

Алматы (727)345-47-04  
Ангарск (3955)60-70-56  
Архангельск (8182)63-90-72  
Астрахань (8512)99-46-04  
Барнаул (3852)73-04-60  
Белгород (4722)40-23-64  
Благовещенск (4162)22-76-07  
Брянск (4832)59-03-52  
Владивосток (423)249-28-31  
Владикавказ (8672)28-90-48  
Владимир (4922)49-43-18  
Волгоград (844)278-03-48  
Вологда (8172)26-41-59  
Воронеж (473)204-51-73  
Екатеринбург (343)384-55-89

Россия +7(495)268-04-70

Иваново (4932)77-34-06  
Ижевск (3412)26-03-58  
Иркутск (395)279-98-46  
Казань (843)206-01-48  
Калининград (4012)72-03-81  
Калуга (4842)92-23-67  
Кемерово (3842)65-04-62  
Киров (8332)68-02-04  
Коломна (4966)23-41-49  
Кострома (4942)77-07-48  
Краснодар (861)203-40-90  
Красноярск (391)204-63-61  
Курск (4712)77-13-04  
Курган (3522)50-90-47  
Липецк (4742)52-20-81

Казахстан +7(727)345-47-04

Магнитогорск (3519)55-03-13  
Москва (495)268-04-70  
Мурманск (8152)59-64-93  
Набережные Челны (8552)20-53-41  
Нижний Новгород (831)429-08-12  
Новокузнецк (3843)20-46-81  
Ноябрьск (3496)41-32-12  
Новосибирск (383)227-86-73  
Омск (3812)21-46-40  
Орел (4862)44-53-42  
Оренбург (3532)37-68-04  
Пенза (8412)22-31-16  
Петрозаводск (8142)55-98-37  
Псков (8112)59-10-37  
Пермь (342)205-81-47

Беларусь +(375)257-127-884

Ростов-на-Дону (863)308-18-15  
Рязань (4912)46-61-64  
Самара (846)206-03-16  
Санкт-Петербург (812)309-46-40  
Саранск (8342)22-96-24  
Саратов (845)249-38-78  
Севастополь (8692)22-31-93  
Симферополь (3652)67-13-56  
Смоленск (4812)29-41-54  
Сочи (862)225-72-31  
Ставрополь (8652)20-65-13  
Сургут (3462)77-98-35  
Сыктывкар (8212)25-95-17  
Тамбов (4752)50-40-97  
Тверь (4822)63-31-35

Узбекистан +998(71)205-18-59

Тольятти (8482)63-91-07  
Томск (3822)98-41-53  
Тула (4872)33-79-87  
Тюмень (3452)66-21-18  
Улан-Удэ (3012)59-97-51  
Ульяновск (8422)24-23-59  
Уфа (347)229-48-12  
Хабаровск (4212)92-98-04  
Чебоксары (8352)28-53-07  
Челябинск (351)202-03-61  
Череповец (8202)49-02-64  
Чита (3022)38-34-83  
Якутск (4112)23-90-97  
Ярославль (4852)69-52-93

Киргизия +996(312)96-26-47

<https://raypa.nt-rt.ru> || [rpa@nt-rt.ru](mailto:rpa@nt-rt.ru)

# Top line vertical autoclaves with state-of-the-art technology

## TLV Series



# Why choose RAYPA?

Expert manufacturer, original design, global brand



### GLOBAL REACH

With half a century of experience, we have a long list of satisfied customers around the world. Currently, we export 85% of our annual turnover and have a stable network of distributors with presence in over 100 countries.



### EFFICIENT TECHNICAL SERVICE

Our team of highly qualified technicians and engineers is expert in our products. If you experience a technical issue, it will be our priority to rectify it. When you purchase a RAYPA unit, you're guaranteed top-level support and technical assistance.



### EXPERT MANUFACTURER

After more than 45 years in the industry, RAYPA is a global leader in the manufacture of laboratory autoclaves. Each of our autoclaves is designed and manufactured entirely within our modern facility equipped with the latest technology.



### FULL AND CUSTOMIZABLE RANGE

We offer an extensive portfolio of laboratory autoclaves to cover multiple applications and market segments. Discover the combination of autoclave model and accessories that best fits your needs within our 11 series and 35 available models.



### INNOVATION AND QUALITY

Our products feature advanced technology, ongoing innovation, superior construction quality, and are designed for a long service life. Our technical and engineering staff works tirelessly every day to optimize our products and exceed our customers' expectations.



### COMPREHENSIVE CONSULTANCY

Our team of specialists assesses each project and provides guidance to clients on the option that best suits their requirements. After the sale, we offer training on the use and recommended maintenance of each unit to ensure its optimal operation and extend its lifespan.

# Autoclaves for the pharmaceutical and biotechnology industries



### TLV-DUAL Series

Designed for an advanced sterilization of liquid and solid loads.

Volumes: 58, 83, 124, and 169 liters.



### TLV-PD Series

Designed for an advanced sterilization of solid loads.

Volumes: 58, 83, 124, and 169 liters.



### TLV-FA Series

Designed for an advanced sterilization of liquid loads.

Volumes: 58, 83, 124, and 169 liters.



### TLV-S Series

Versatile for general applications.

Volumes: 58, 83, 124, and 169 liters.

"Engineered to exceed your requirements, even the most demanding ones"



### Exceptional build quality

We build our products using only top-tier materials, ensuring unrivaled durability and operational reliability in the most demanding environments.



### Modern design

Our autoclaves feature a modern design paired with ergonomic precision, offering a user experience that surpasses current industry norms.



### State-of-the-art innovation

We fuse advanced engineering with forward-thinking design to deliver superior performance and productivity.



### Sustainable manufacturing

Designed for the future, our autoclaves are designed with energy efficiency and space optimization at the forefront, completely eliminating reliance on fossil fuels and incorporating fully digitalized quality management systems.



### Safety first, comfort always

Prioritizing safety and user-friendliness, our autoclaves ensure a secure operation for both operators and the items being sterilized.



### Swift installation

Our autoclaves are designed for easy installation, ensuring they are immediately operational and can be relocated as needed to meet changing space requirements.



### Total control, advanced technical assistance and professional traceability

Our solutions empower you with centralized control over traceability, ensuring seamless digital quality management coupled with advanced technical support.

"World-class management of digital quality in compliance with FDA and GMP standards"

## Exceptional build quality

**Our autoclaves are designed to deliver exceptional durability and outstanding operational reliability.**



The external housing is made of AISI-304 stainless steel, while the sterilization chamber is made of high-quality AISI-316L stainless steel, providing exceptional corrosion resistance.



All our autoclaves are manufactured in compliance with the European Pressure Equipment Directive (PED) 2014/68/EU requirements. Optionally, they can be manufactured under ASME VIII Div-1 and CRN certification.



The design codes for all our autoclave chambers are in accordance with the AD 2000 Merkblatt standards. Optionally, they can be manufactured in accordance with the design code of ASME Section VIII Div-1.



## Modern design

**All the features and components necessary to perform any type of application.**



\*The availability of these components depends on the selected model.

# State-of-the-art innovation

Our autoclaves are designed with advanced engineering and exceptional quality in every detail, ensuring consistent and fully traceable results.



### Modern 7" touchscreen display

Navigate all device features effortlessly with our modern touchscreen display, designed for an intuitive user experience, ensuring clarity and precision in every interaction.

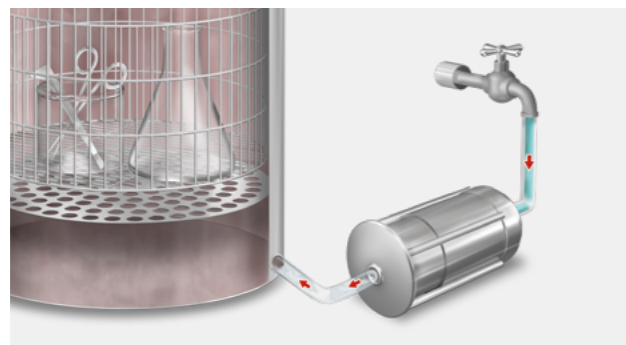

### Instant production of steam

The built-in steam generator in every unit delivers immediate, high-quality steam, shortening the heating phase and enabling the efficient processing of complex loads, enhancing the homogeneity and the operational performance.

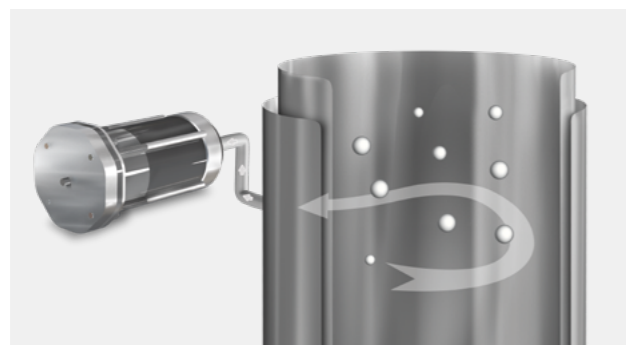

### Mechanical extraction of cold air

All models incorporate a vacuum pump to perform a prevacuum phase before steam injection, enhancing steam penetration and overall performance.



### Optimized monitoring of temperature

The chamber and flexible probes enable accurate, real-time monitoring of temperatures, ensuring optimal performance and consistent process conditions.

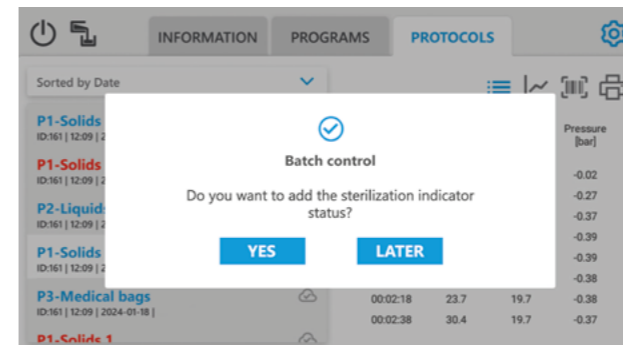

### Enhanced batch control

Comprehensive and automated batch process management. It allows you to schedule and monitor multiple batches, as well as generate detailed reports, ensuring complete quality control in every production cycle.



### RAYPAtrace

RAYPAtrace provides a straightforward and professional solution for creating, identifying, and tracking each batch with unique labels, ensuring reliable documentation. To utilize this feature, purchasing our label printer and barcode scanner is required.



### Advanced F<sub>0</sub> sterilizations

This method enables an accurate quantification and assessment of the sterilization process's efficiency. Its versatility is particularly advantageous in contexts where exposure to high temperatures could compromise the integrity of the materials being processed.



### Streamlined and fully digital management of quality

We offer customized solutions for managing the digital quality of the controller and the external management platform RAYPAcloud, tailored to each client. Our options include public and private solutions that comply with FDA standards and can be integrated via Docker into local servers, LIMS systems, and Active Directory.

# Safety first, comfort always

Our Top line autoclaves are fully automatic, providing maximum comfort and peace of mind in every operation.



### Effortless push-button door operation

With the press of a button, the autoclave door opens and closes automatically, making operation easier and safer while reducing operator strain. This advanced system improves ergonomics, lowers the risk of injury, and increases overall productivity.

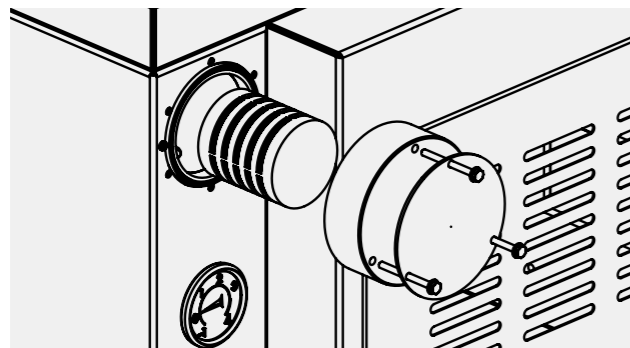

### Bacteriological filter for air inlet and outlet

The bacteriological filter guarantees that all air circulating in and out of the autoclave remains completely sterile, ensuring a safe environment for both staff and materials during the entire sterilization process.

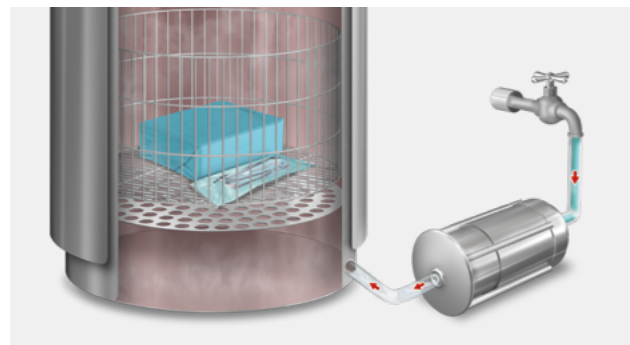

### Automatic water filling

All Top line autoclaves are equipped with a water pump and feature automated steam generator filling, guaranteeing a continuous and efficient steam supply during operation.



### Direct refrigerated discharge

All models are equipped with an active cooling system that uses a heat exchanger connected to the main water supply. This system reduces the temperature of gas and liquid emissions to a safe level before discharge.



## Swift and hassle-free installation

### Effortless mobility

Antistatic wheels with integrated brakes facilitate the mobility of the equipment, allowing it to be moved effortlessly and ensuring a quick and secure installation in any environment.

### Flexible installation options

Standard installation requires a purified water inlet and a drain, but we provide alternative solutions to accommodate environments where these resources are not available, ensuring a seamless installation process.

### Enhanced load management

For the safe and effortless handling of heavy baskets in large-volume autoclaves, we recommend a basket lift system, which can be either integrated into the unit or provided as a mobile solution to streamline the process.

# Our Top line autoclaves are an excellent alternative to floor-standing horizontal autoclaves

## Floor-standing horizontal autoclaves

## Our autoclaves

### Sustainability

Often equipped with a fast cooling jacket that uses substantial amounts of water, these units also rely on a central steam boiler that needs to operate non-stop, resulting in a significant environmental footprint due to high fossil fuel consumption.

They operate on electricity, are fully self-sufficient, and do not require a central boiler. They consume less water and energy per cycle and comply with strict EU regulations on emissions and energy efficiency.

### Spatial efficiency

Large footprint with inefficient use of space, compromising the operational layout of the laboratory.

Compact, vertical design that maximizes space utilization with an excellent size-to-useful-volume ratio.

### Cost efficiency

They come with a high acquisition cost, and their maintenance is both expensive and complex. Additionally, as square chambers with thick walls covered by a cooling jacket, they have high energy and water consumption per cycle.

More economical acquisition cost and simplified maintenance. They are more efficient and have lower energy and water consumption per cycle.

### Installation

Require major site modifications, special utility connections, a ventilation system and often a connection to a central boiler, increasing setup costs and complexity of installation. Their relocation is difficult.

No significant investment is required in site renovations or special utility connections. They only need a water inlet and a drain outlet, as they integrate their own steam generator and air compressor. Additionally, they can be easily relocated if necessary.

### Maintenance and replacement

Maintenance is complex and costly due to its integration into the building's infrastructure, which may involve the disruption of other services during repairs.

Easy to maintain and repair both on-site and at the factory. Maintenance and repair tasks are simplified thanks to easy access to all components of the equipment.

### Lead times

Long manufacturing times, up to a year, especially for custom or bespoke models.

Lead times range between 4 and 8 weeks, or immediately if a unit is in stock, allowing for rapid commissioning.

### Versatility and processing quality

Although designed to handle large volumes and diverse loads, they are often used for small loads, leading to unnecessary energy consumption.

They offer the same processing quality as larger steam sterilizers and have chamber volumes ranging from 33L to 169L. Additionally, they allow for the processing of any type of load.

### Use as support units

They are typically installed as single units, so a failure or maintenance task can cause significant downtime and severely impact laboratory productivity.

They can be relocated if necessary. They are also used as a backup resource to process small load volumes, manage peaks of demand, or handle unforeseen situations.



“Models available with capacities up to 169L”

# Total control, advanced technical support, and professional traceability

Top line autoclaves set a new standard for efficiency by incorporating centralized management of digital quality and AI-powered predictive maintenance to prevent downtime.



Capacitive screen, control over all parameters, real-time program visualization, user control, and access to protocol history. Possibility of integration on Active Directory.



Advanced technical support. Predictive maintenance based on AI, request for technical assistance and scheduling appointments through the controller, screen sharing via TeamViewer®, and remote diagnosis of equipment status.



Centralized management, customized reports, integrated device management, alerts, traceability for audits, and SSL encryption. Possibility of integration on private server through Docker or within a LIMS system.

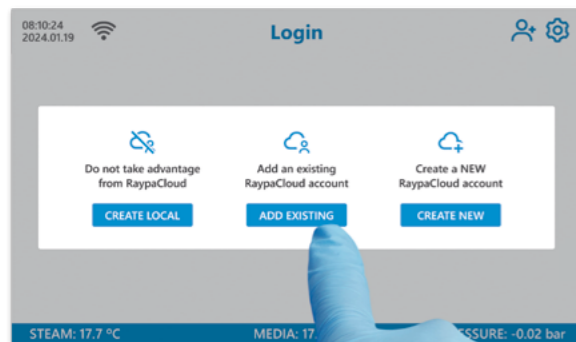

# Comprehensive management of digital quality

Our RAYPAcloud management platform enables secure and centralized management of all autoclave operations, with options for both private and public solutions.



- ✓ Digital solution, eliminate paperwork.
- ✓ Total security.
- ✓ Streamlined maintenance schedule management.
- ✓ AI-driven predictive maintenance identifies irregular performance and sends alerts to prevent downtime.
- ✓ Receive customized reports.
- ✓ Centralized management of multiple devices across different locations.
- ✓ Cross-device notifications and alerts.
- ✓ Wireless programming (over-the-air updates).

# Most preferred modalities for managing your autoclave's digital quality

## Private standard

Modality that installs the RAYPAcloud management platform on a local server, ensuring absolute privacy and security while facilitating centralized management. All FDA functions must be enabled for this setup. Access to the management platform is provided through a local area network. The server can be provided by the client or supplied by RAYPA.

## Cloud standard

A modality that enables all connectivity and remote diagnosis features. This requires an active public license for RAYPAcloud. Data is securely stored in the cloud, and any authorized device can access the management platform online.

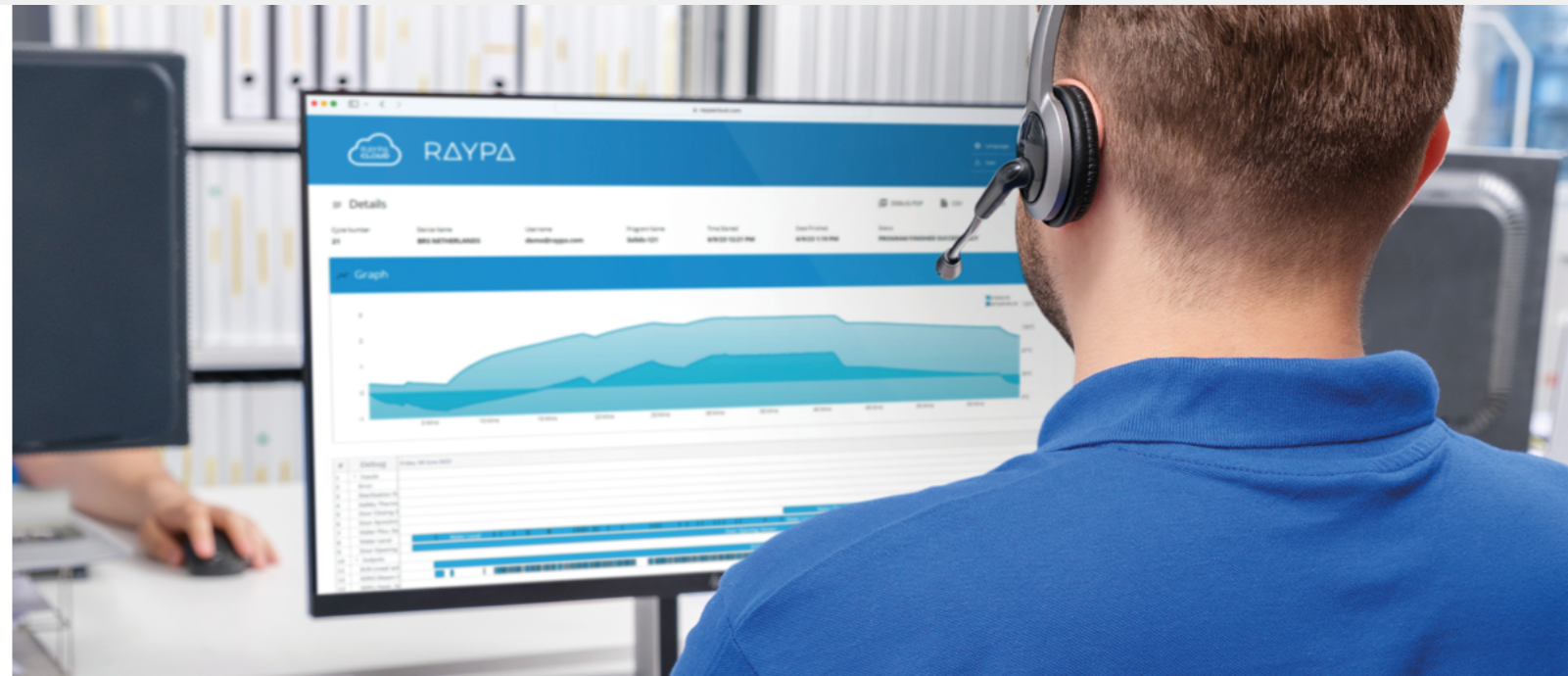

**Recommended for customers in the pharmaceutical, biotech, cosmetics, and food industries working within FDA and GMP-regulated environments.**

- ✓ Instant access to all audit trails of actions performed both on the controller and on the management platform.
- ✓ Remote diagnosis of equipment status must be conducted synchronously using TeamViewer®.
- ✓ Automatic upload of controller software backups on the private server.
- ✓ Controller and management platform must be updated manually.
- ✓ IQ/OQ qualification for FDA Title 21 CFR Part 11 compliance is offered for both the controller software and the management platform software.

**Recommended for institutional customers and private enterprises that do not need to comply with FDA Title 21 CFR Part 11.**

- ✓ Equipment status can be diagnosed remotely and asynchronously by the manufacturer's technical team or any authorized service provider.
- ✓ After granting permission, the controller's screen can be shared via TeamViewer®.
- ✓ Centralized management of multiple devices across different locations.
- ✓ Management of notifications and alerts via email or SMS.
- ✓ Data transfer and retrieval from the equipment controller can be executed via the management platform.
- ✓ User administration and program management for each device can be controlled remotely.
- ✓ Data is securely stored in the cloud on AWS servers located in the EU or the USA.

# Choose your preferred modality for managing your autoclave's digital quality

We offer multiple modalities for managing the digital quality of the data stored in the autoclave's microprocessor and on the RAYPAcloud management platform. Additionally, we have a team of specialists who provide specific developments and technical support during the integration and maintenance of the chosen modality.

	FDA			FDA		
	PRIVATE STANDARD	CLOUD-COMPLY	ESSENTIAL-COMPLY	PRIVATE BASIC	CLOUD STANDARD	ESSENTIAL
<b>Equipment controller</b>						
Real-time visualization of cycle status	✓	✓	✓	✓	✓	✓
Video instructions	✓	✓	✓	✓	✓	✓
Allows direct contact with technical support	-	✓	-	-	✓	-
The screen of the controller can be shared	-	✓	-	-	✓	-
Managing email notifications and alerts	-	✓	-	-	✓	-
User administration control with passwords	✓	✓	✓	✓	✓	✓
Data transfer and retrieval from RAYPAcloud	✓	✓	-	✓	✓	-
Access and export the audit trails for all actions and perform comprehensive backups	✓	✓	✓	-	-	-
<b>Management platform</b>						
Mode for accessing the management platform	Offline via local area network	Online via the internet	-	Offline via local area network	Online via the internet	-
Centralized management of multiple devices	✓	✓	-	✓	✓	-
User administration control with passwords	✓	-	-	✓	-	-
Remote editing of sterilization programs	-	-	-	✓	✓	-
Real-time visualization of cycle status	✓	✓	-	✓	✓	-
Cycle history is automatically saved on the management platform	✓	✓	-	✓	✓	-
All audit trails and backups of the controller software are automatically saved in the management platform	✓	✓	-	-	-	-
Access and export the audit trails for all actions performed in the management platform.	✓	✓	-	-	-	-
Wireless programming of controller software and management software (over-the-air updates)	-	✓	-	-	✓	-
RAYPA or any authorized company can access the user's account and perform a remote diagnosis of the equipment's status at any time	-	✓	-	-	✓	-
Method for performing a remote diagnosis	TeamViewer® and synchronous	Asynchronous	-	TeamViewer® and synchronous	Asynchronous	-
Predictive maintenance based on AI	✓	✓	-	✓	✓	-
<b>Digital quality management</b>						
The administrator can retrieve unencrypted data from the controller with a USB stick	✓	✓	✓	✓	✓	✓
The information stored on the management platform is encrypted	✓	✓	-	✓	✓	-
Location where the management platform data is stored	Local server	AWS (USA or EU)	N/A	Local server	AWS (USA or EU)	N/A
Integration on Active Directory	0	0	0	0	0	0
Integration on LIMS	0	-	-	0	-	-
The information stored in the autoclave controller complies with FDA Title 21 CFR Part 11	✓	✓	✓	-	-	-
The information stored in the management platform complies with FDA Title 21 CFR Part 11	✓	-	N/A	-	-	N/A

✓: Included 0: Optional N/A: Not applicable





**Private standard:** Data is stored in the autoclave controller and on a private server. Access to the management platform is offline via any device connected to the local area network. Data management at both the controller and management platform complies with FDA Title 21 CFR Part 11.  
**Cloud-comply:** Data is stored in the autoclave controller and in the cloud (AWS USA or EU). Access to the management platform is online via any device connected to the internet. Data management at the controller complies with FDA Title 21 CFR Part 11.  
**Essential-comply:** Data is stored exclusively in the autoclave controller, and its management complies with FDA Title 21 CFR Part 11.  
**Private basic:** Data is stored in the autoclave controller and on a private server. Access to the management platform is offline via any device connected to the local area network.  
**Cloud standard:** Data is stored in the autoclave controller and in the cloud (AWS USA or EU). Access to the management platform is online via any device connected to the internet.  
**Essential:** Data is stored exclusively in the autoclave controller.





# Choosing your Top line autoclave

## 1 Select the series that best fits your needs:

Series				
	TLV-DUAL Series	TLV-FA Series	TLV-PD Series	TLV-S Series
Compatible applications				
Culture media and liquids	++	++	++	++
Glassware	++	++	++	++
Laboratory waste bags	++	+	++	+
Biohazardous waste	++	+	++	+
Porous solids and wrapped objects	++	-	++	-
Objects with complex geometries	++	-	++	-
Prefilled syringes and hermetically sealed items	++	++	-	-
Integrated steam generator	✓	✓	✓	✓
Fast cooling system with fan and water cooling coil	✓	✓	-	-
Pressure support via air compressor	✓	✓	-	-
Super-drying system with liquid-ring pump and heating jacket	✓	-	✓	-
Type of prevacuum	Fractionated	Single	Fractionated	Single
Post-vacuum with drying	✓	-	✓	-
Automatic water feed from the network	✓	✓	✓	✓
Direct refrigerated discharge	✓	✓	✓	✓
Bacteriological filter for air inlet	✓	✓	✓	✓
Bacteriological filter for air outlet	0	0	0	0
Main flexible probe	✓	✓	0	0
Additional flexible probe	0	0	0	0

++ Recommended ✓ Included 0 Optional

## 2 Choose the ideal size for your laboratory:

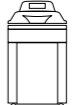
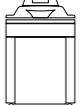
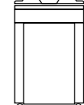
				
Models	TLV-50	TLV-75	TLV-110	TLV-150
Total/usable volume of the chamber L	58/56	83/81	124/118	169/155
Usable dimensions of the chamber Ø x H mm	400 x 450	400 x 650	500 x 600	500 x 850
External dimensions L x D x H mm	610 x 870 x 1060	610 x 870 x 1100	710 x 980 x 1160	710 x 980 x 1310
Loading height mm	815	865	915	1065
Net weight Kg	131	139	195	210
Power W	3600	3600	9000	9000
Standard voltage* V	230	230	400	400
Frequency Hz	50/60	50/60	50/60	50/60

\*Other voltages and electrical configurations available on request. Special models with increased power can operate with other voltages.



TLV-DUAL Series

# Autoclaves with super-drying and fast cooling system



Designed for an advanced sterilization of solids and liquids, fully automatic and featuring a modern and ergonomic design. Additionally, they offer professional traceability and advanced connectivity.



Culture media and liquids



Glassware



Laboratory waste bags



Biohazardous waste



Porous solids and wrapped objects



Objects with complex geometries



Prefilled syringes and hermetically sealed items

## Advanced sterilization of solid loads

In the prevacuum phase, the air of the chamber is purged with multiple vacuum pulses. After the first vacuum pulse, the steam generator is activated, injecting saturated steam into the chamber until the required temperature is reached. This temperature is accurately sustained for the predefined duration to sterilize the load. Subsequently, the vacuum pump and the heating jacket dry the load. Finally, a fast cooling phase begins.

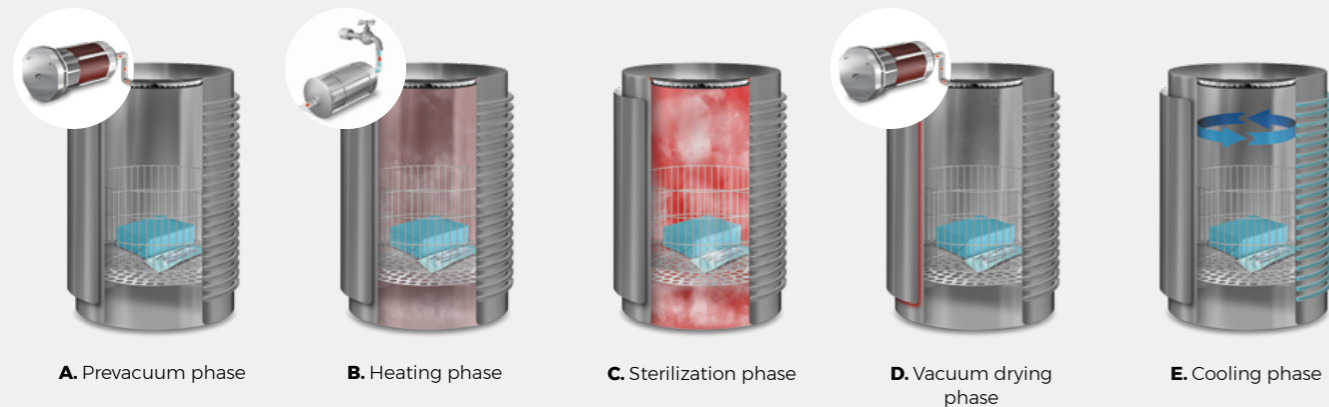
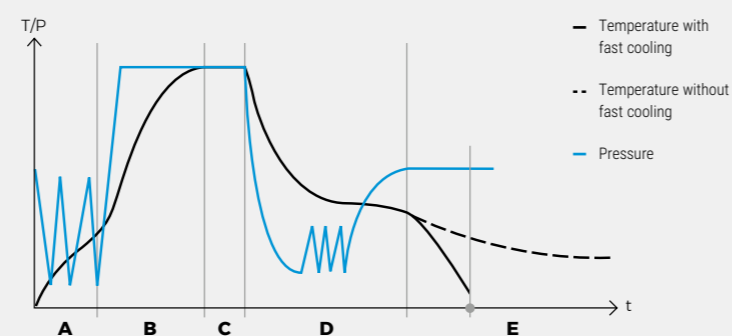

## Advanced sterilization of liquid loads

In the prevacuum phase, the air of the chamber is purged with a single vacuum pulse. Then, the steam generator is activated, injecting saturated steam into the chamber until the appropriate temperature is reached. This temperature is accurately sustained for the predefined duration to sterilize the load. Finally, a fast cooling phase with pressure support starts, activating the water cooling coil and the internal radial fan.

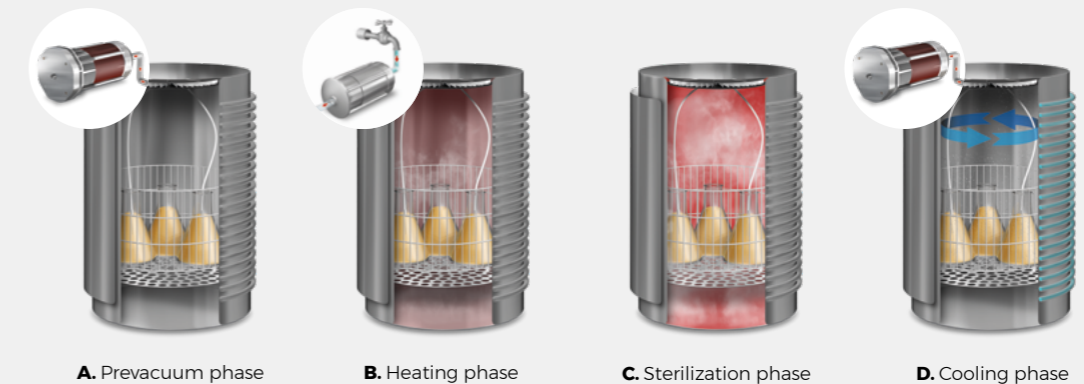
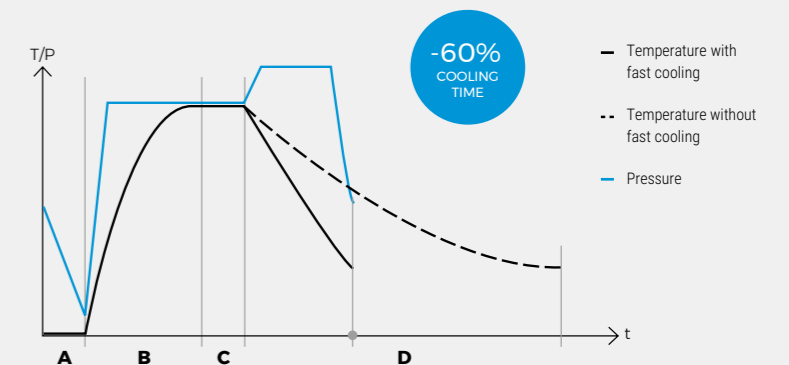



## TLV-FA Series Autoclaves with fast cooling system

Fully automatic,  
advanced sterilization  
of liquids, modern  
design, professional  
traceability, and  
advanced connectivity.



Culture media and  
liquids



Glassware



Laboratory waste bags



Biohazardous waste



Prefilled syringes and  
hermetically sealed items

### Advanced sterilization of liquid loads

In the prevacuum phase, the air of the chamber is purged with a single vacuum pulse. Then, the steam generator is activated, injecting saturated steam into the chamber until the appropriate temperature is reached. This temperature is accurately sustained for the predefined duration to sterilize the load. Finally, a fast cooling phase with pressure support starts, activating the water cooling coil and the internal radial fan.

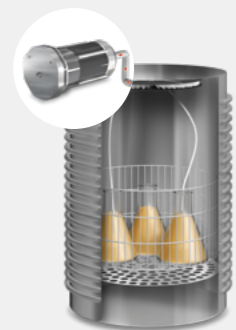
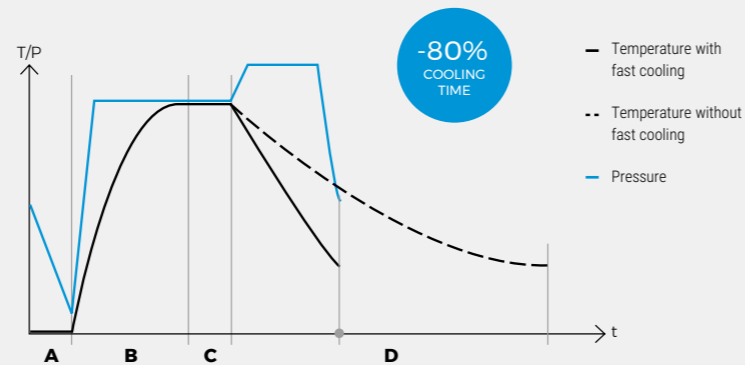

A. Prevacuum phase

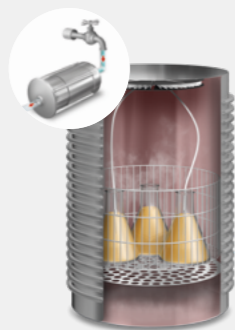

B. Heating phase

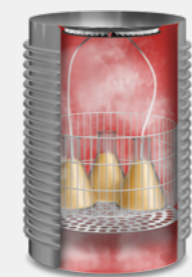

C. Sterilization phase

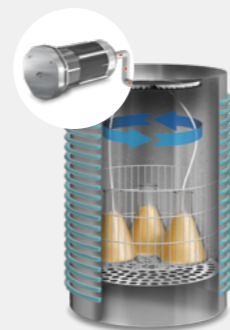

D. Cooling phase



## TLV-PD Series Autoclaves with super-drying system

Fully automatic,  
advanced sterilization of  
solids, modern design,  
professional traceability,  
and advanced  
connectivity.



Culture media and  
liquids



Glassware



Laboratory waste bags



Biohazardous waste



Porous solids and  
wrapped objects



Objects with complex  
geometries

### Advanced sterilization of solid loads

In the prevacuum phase, the air of the chamber is purged with multiple vacuum pulses. After the first vacuum pulse, the steam generator is activated, injecting saturated steam into the chamber until the required temperature is reached. This temperature is accurately sustained for the predefined duration to sterilize the load. Subsequently, the vacuum pump and heating jacket dry the load. Finally, a natural cooling phase begins.

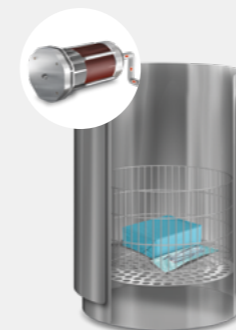
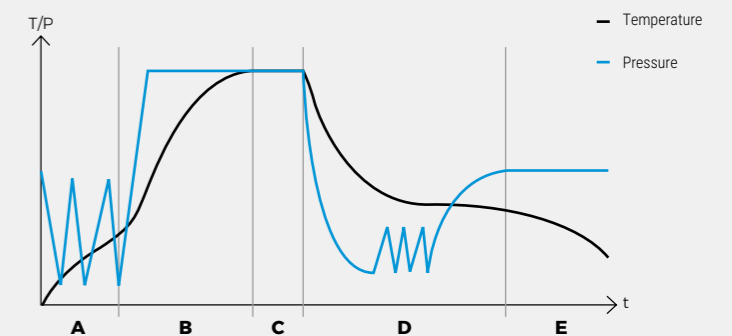

A. Prevacuum phase

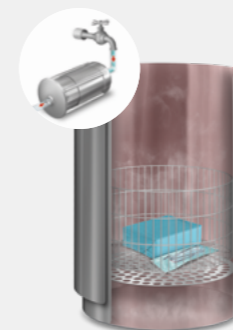

B. Heating phase

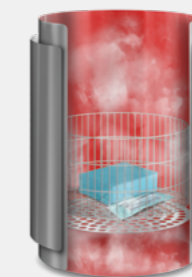

C. Sterilization phase

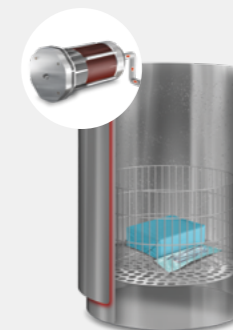

D. Vacuum drying  
phase

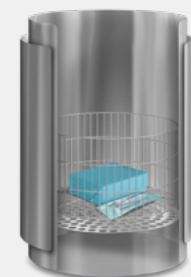

E. Cooling phase

# Accessories

## General accessories



### Label printer and barcode scanner

Allows printing and reading individual labels for each processed load, facilitating precise identification of each batch.

**Ref. ITS-LAB and BAR-SCAN**



### External dot matrix printer

It prints the program number, cycle number, temperature, duration, date and time of each sterilization, and error messages.

**Ref. ITS-TLV**



### Embedded thermal printer

It prints the program number, cycle number, temperature, duration, date and time of each sterilization, and error messages.

**Ref. IT/TLV**



### Flexible probe

Allows for accurate control of the temperature reached at the center of the liquid sample, ensuring correct sterilization of the load.

**Ref. PT-2-TLV and PT-2-TLV-PD**



### Pack of Bowie-Dick tests

Class B indicator to check the correct penetration of steam in porous loads. Recommended for models of the TLV-DUAL and TLV-PD Series.

**Ref. TEST-BD**



### Sterilization tape

Class 1 indicator whose color change indicates that the materials have been processed. For enhanced assurance, additional methods such as biological indicators (EN ISO 11138) are required.

**Ref. TEST-CT**



### Eco-efficient water purifier

Provides purified water directly to the steam generator for optimal operation.

**Ref. ECOPUR-TLV**



### Water softener

Prevents scale deposits inside pipes, the cooling system, and the sterilization chamber. Recommended for models of the TLV-DUAL and TLV-FA Series.

**Ref. WATERSOFT-TLV**



### Purified water tank

Alternative solution for storing purified water in the absence of a water network. Recommended for models of the TLV-S and TLV-PD Series.

**Ref. TANK-TLV and TANK-TLV-PD**

## Accessories for handling loads



### Integrated basket lift system

Stainless steel electric lift system built into the side of the autoclave with swivel arm to help load and unload heavy items up to 30Kg.

**Ref. FIX-LIFT**



### Mobile basket lift system

Stainless steel electric lift system with a battery and casters to help load and unload heavy items up to 30Kg.

**Ref. MOB-LIFT**



### Wire baskets

AISI-304 stainless steel baskets suitable for sterilizing all types of clean loads.

**Ref. CV**



### Wire basket trays

AISI-304 stainless steel trays to be used in conjunction with wire baskets to collect liquids.

**Ref. TR**



### Unperforated baskets

AISI-304 stainless steel baskets suitable for sterilizing dirty loads and those with a risk of spillage.

**Ref. CCI**



### Schimmelbusch drum

AISI-304 stainless steel drum suitable for sterilizing instruments and biohazardous loads.

**Ref. TBE**



### Height adjustable tray support

AISI-304 stainless steel support suitable for sterilizing instruments, small bags, and other low-height objects that require stable, flat positioning.

**Ref. SRA**

# We are the ideal partner for your laboratory

## Tailored consultancy

From our initial start-up offer to carrying out maintenance or supplying spare parts, our team will accompany you every step of the way, ensuring a comprehensive and personalized solution tailored to your requirements.

## Global network of technical service providers

We have an excellent in-house technical service and a network of authorized local technicians spread across the globe who undergo regular factory training.

## After-sales services

We offer a full range of services to ensure a satisfactory user experience throughout the entire lifespan of our products.

-  **Support and training programs**
-  **Guided start-up and qualification services**
-  **Preventive, predictive and corrective maintenance**
-  **Periodic calibration**
-  **Technical support and repairs**
-  **Documentation management**

## Commissioning and qualification services

Our highly skilled technical team provides specialized assistance and qualification services that ensure maximum functionality and operational safety for each piece of equipment, offering peace of mind and continuous support to our clients.



### Remote commissioning

Offers a remote training session focused on the correct usage and maintenance of the equipment.

**Ref. INSTLV-REM**



### On-site commissioning

Includes a thorough verification of installation and operational functionality, as well as hands-on training for equipment use and maintenance.

**Ref. INSTLV**



### IQ-OQ documentation

Provision of the IQ/OQ documentation and protocols required for third-party qualification of the autoclave.

**Ref. IQ-OQ DOC**



### IQ-OQ-PQ qualification

Complete IQ/OQ/PQ qualification of your autoclave, expertly performed by RAYPA.

**Ref. IQ/OQ/PQ**



## Special adaptations

### Customization of accessories and tailored solutions

Thanks to our in-house R&D department, we have the capacity to meet novel requirements from our customers by adapting our accessories or creating specific solutions for them.

For instance, with our FIX-LIFT and MOB-LIFT cranes, we can tailor the height of the vertical column to fit specific ceiling heights or increase it to enhance crane clearance. Additionally, we can customize the baskets or create specialized basket supports to accommodate and handle large items like bioreactors.

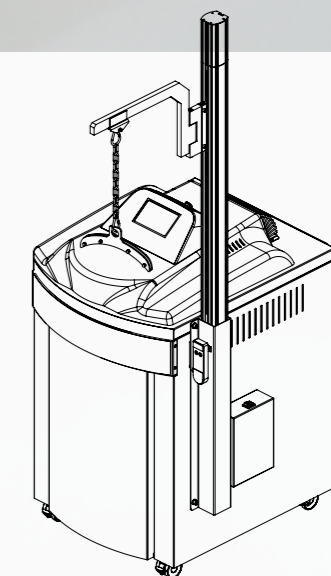

Top line autoclave equipped with the FIX-LIFT crane

# RAYPA



**Алматы** (727)345-47-04  
**Ангарск** (3955)60-70-56  
**Архангельск** (8182)63-90-72  
**Астрахань** (8512)99-46-04  
**Барнаул** (3852)73-04-60  
**Белгород** (4722)40-23-64  
**Благовещенск** (4162)22-76-07  
**Брянск** (4832)59-03-52  
**Владивосток** (423)249-28-31  
**Владикавказ** (8672)28-90-48  
**Владимир** (4922)49-43-18  
**Волгоград** (844)278-03-48  
**Вологда** (8172)26-41-59  
**Воронеж** (473)204-51-73  
**Екатеринбург** (343)384-55-89

**Россия** +7(495)268-04-70

**Иваново** (4932)77-34-06  
**Ижевск** (3412)26-03-58  
**Иркутск** (395)279-98-46  
**Казань** (843)206-01-48  
**Калининград** (4012)72-03-81  
**Калуга** (4842)92-23-67  
**Кемерово** (3842)65-04-62  
**Киров** (8332)68-02-04  
**Коломна** (4966)23-41-49  
**Кострома** (4942)77-07-48  
**Краснодар** (861)203-40-90  
**Красноярск** (391)204-63-61  
**Курск** (4712)77-13-04  
**Курган** (3522)50-90-47  
**Липецк** (4742)52-20-81

**Казахстан** +7(727)345-47-04

**Магнитогорск** (3519)55-03-13  
**Москва** (495)268-04-70  
**Мурманск** (8152)59-64-93  
**Набережные Челны** (8552)20-53-41  
**Нижний Новгород** (831)429-08-12  
**Новокузнецк** (3843)20-46-81  
**Ноябрьск** (3496)41-32-12  
**Новосибирск** (383)227-86-73  
**Омск** (3812)21-46-40  
**Орел** (4862)44-53-42  
**Оренбург** (3532)37-68-04  
**Пенза** (8412)22-31-16  
**Петрозаводск** (8142)55-98-37  
**Псков** (8112)59-10-37  
**Пермь** (342)205-81-47

**Беларусь** +(375)257-127-884

**Ростов-на-Дону** (863)308-18-15  
**Рязань** (4912)46-61-64  
**Самара** (846)206-03-16  
**Санкт-Петербург** (812)309-46-40  
**Саранск** (8342)22-96-24  
**Саратов** (845)249-38-78  
**Севастополь** (8692)22-31-93  
**Симферополь** (3652)67-13-56  
**Смоленск** (4812)29-41-54  
**Сочи** (862)225-72-31  
**Ставрополь** (8652)20-65-13  
**Сургут** (3462)77-98-35  
**Сыктывкар** (8212)25-95-17  
**Тамбов** (4752)50-40-97  
**Тверь** (4822)63-31-35

**Узбекистан** +998(71)205-18-59

**Тольятти** (8482)63-91-07  
**Томск** (3822)98-41-53  
**Тула** (4872)33-79-87  
**Тюмень** (3452)66-21-18  
**Улан-Удэ** (3012)59-97-51  
**Ульяновск** (8422)24-23-59  
**Уфа** (347)229-48-12  
**Хабаровск** (4212)92-98-04  
**Чебоксары** (8352)28-53-07  
**Челябинск** (351)202-03-61  
**Череповец** (8202)49-02-64  
**Чита** (3022)38-34-83  
**Якутск** (4112)23-90-97  
**Ярославль** (4852)69-52-93

**Киргизия** +996(312)96-26-47

<https://raypa.nt-rt.ru> || [rpa@nt-rt.ru](mailto:rpa@nt-rt.ru)